















Renvooi

verkoop

-  WCD 230V enkelvoudig
-  WCD 230V dubbelvoudig
-  Schakelaar 230V enkelpolig
-  Schakelaar 230V serie
-  Wisselschakelaar 230V dubbelpolig
-  Aansluitpunt bedraad
-  Aansluitpunt loos
-  Wand lichtpunt
-  Centrale doos
-  Rookmelder
-  Videofoon
-  Drukknop

- th thermostaat
- mk meterkast
- CO2 CO2 meter

-  Inblaasventiel MV
-  Afzuigventiel MV
-  Inblaasventiel MV wand
-  Radiator
-  Vloerverwarming
-  Verwarming verdeler
-  MV-box met warmterugwinning
-  Opstelplaats voor wasmachine

-  Vloertegelwerk
-  Schacht
-  Verlaagd plafond
-  Kolom
-  Wand
-  Deur

Maatvoering is niet geschikt voor opdrachten van koper aan derden.

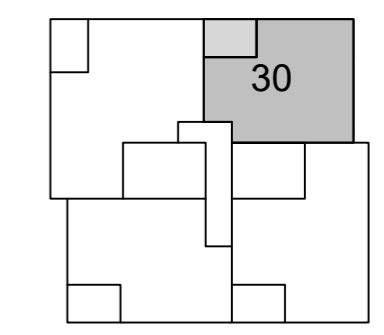
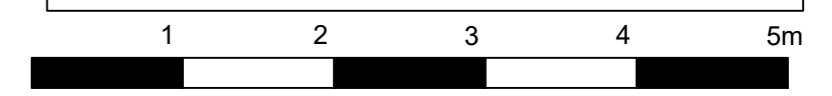

tweede verdieping

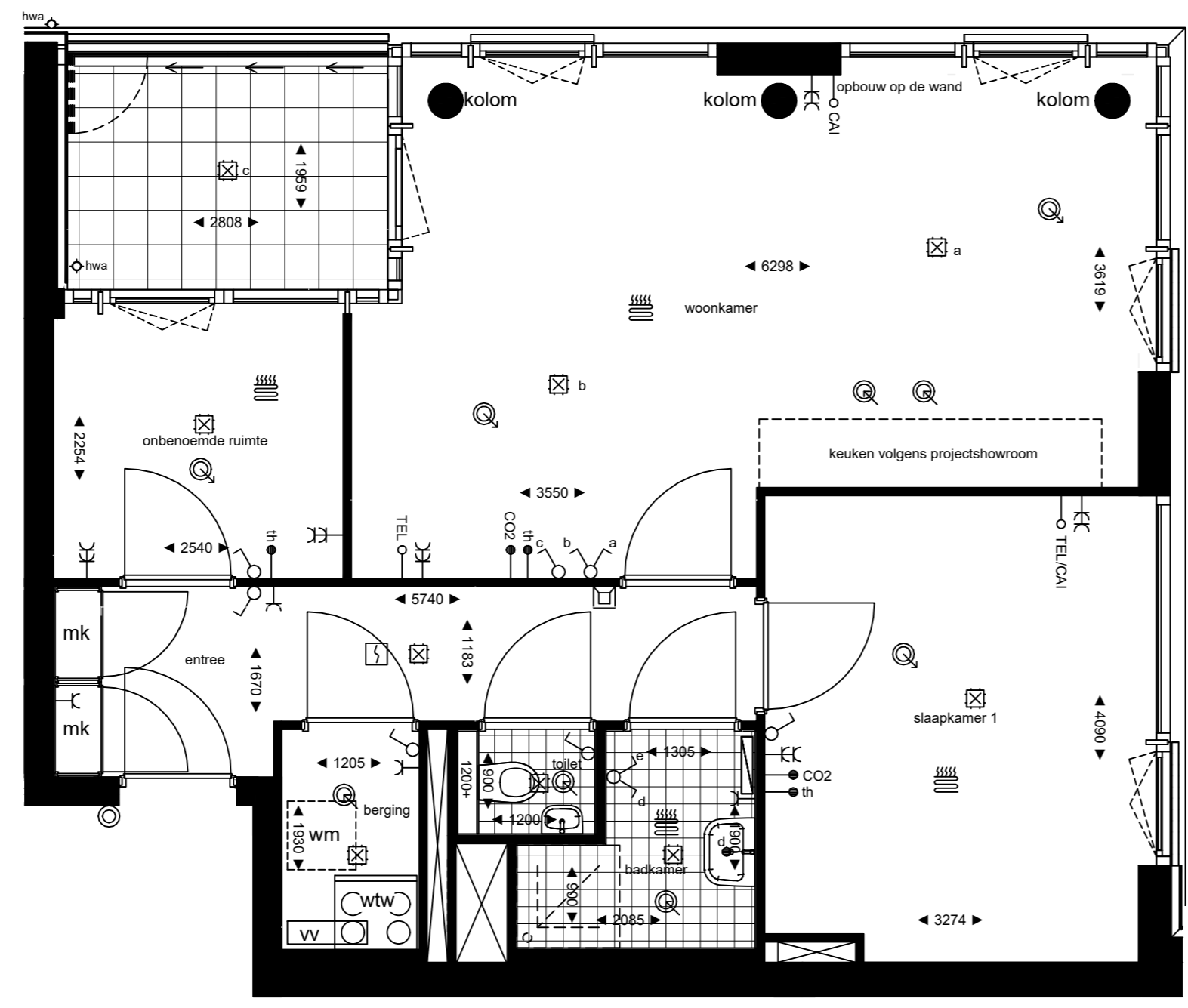

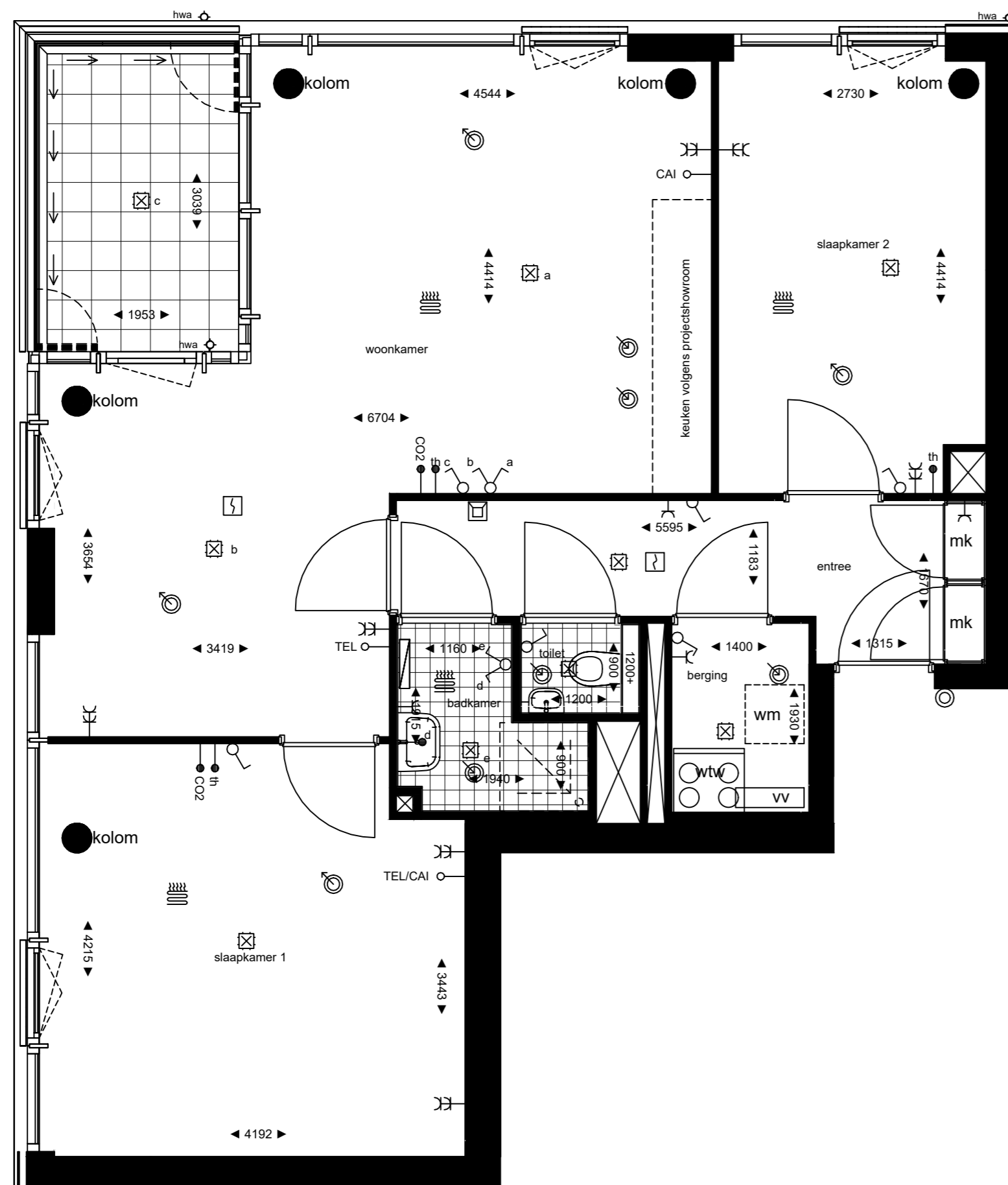















Renvooi

verkoop

-  WCD 230V enkelvoudig
-  WCD 230V dubbelvoudig
-  Schakelaar 230V enkelpolig
-  Schakelaar 230V serie
-  Wisselschakelaar 230V dubbelpolig
-  Aansluitpunt bedraad
-  Aansluitpunt loos
-  Wand lichtpunt
-  Centrale doos
-  Rookmelder
-  Videofoon
-  Drukknop

- th thermostaat
- mk meterkast
- CO2 CO2 meter

-  Inblaasventiel MV
-  Afzuigventiel MV
-  Inblaasventiel MV wand
-  Radiator
-  Vloerverwarming
-  Verwarming verdeler
-  MV-box met warmterugwinning
-  Opstelplaats voor wasmachine

-  Vloertegelwerk
-  Schacht
-  Verlaagd plafond
-  Kolom
-  Wand
-  Deur

Maatvoering is niet geschikt voor opdrachten van koper aan derden.

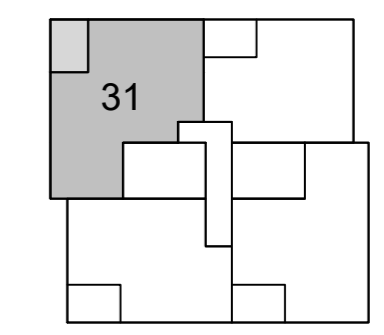
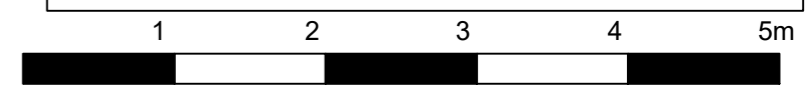

tweede verdieping

















Renvooi

verkoop

-  WCD 230V enkelvoudig
-  WCD 230V dubbelvoudig
-  Schakelaar 230V enkelvoudig
-  Schakelaar 230V serie
-  Wisselschakelaar 230V dubbelpolig
-  Aansluitpunt bedraad
-  Aansluitpunt loos
-  Wand lichtpunt
-  Centrale doos
-  Rookmelder
-  Videofoon
-  Drukknop

- th thermostaat
- mk meterkast
- CO2 CO2 meter

-  Inblaasventiel MV
-  Afzuigventiel MV
-  Inblaasventiel MV wand
-  Radiator
-  Vloerverwarming
-  Verwarming verdeler
-  MV-box met warmterugwinning
-  Opstelplaats voor wasmachine

-  Vloertegelwerk
-  Schacht
-  Verlaagd plafond
-  Kolom
-  Wand
-  Deur

Maatvoering is niet geschikt voor opdrachten van koper aan derden.

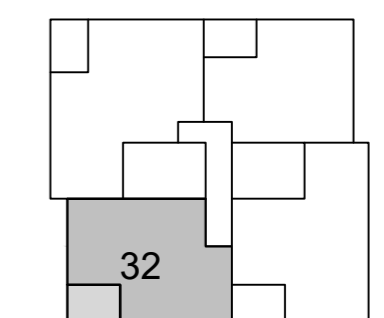
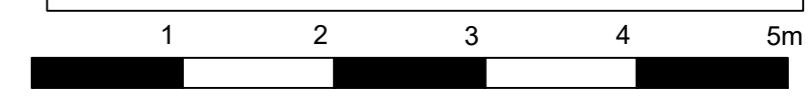

tweede verdieping

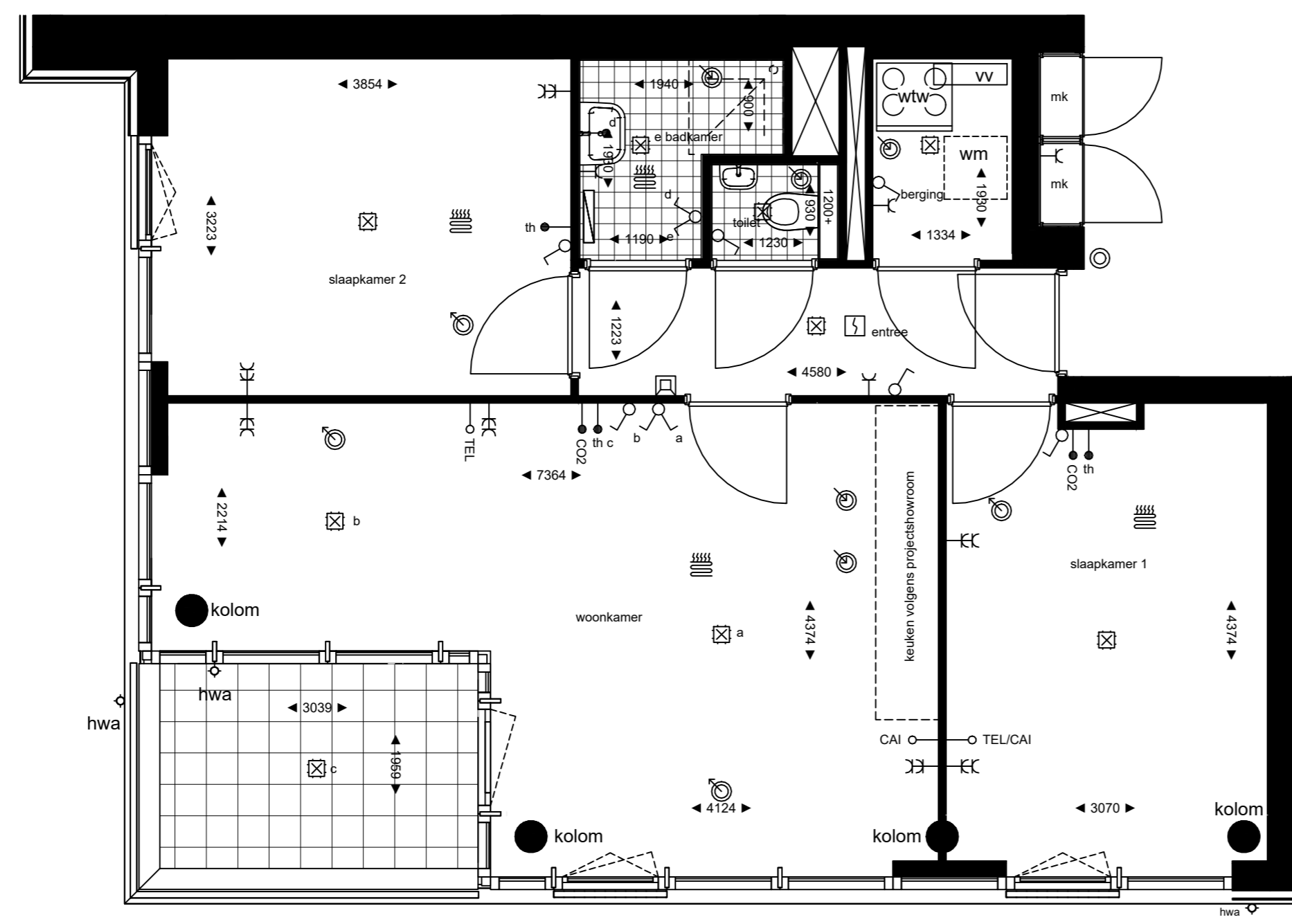

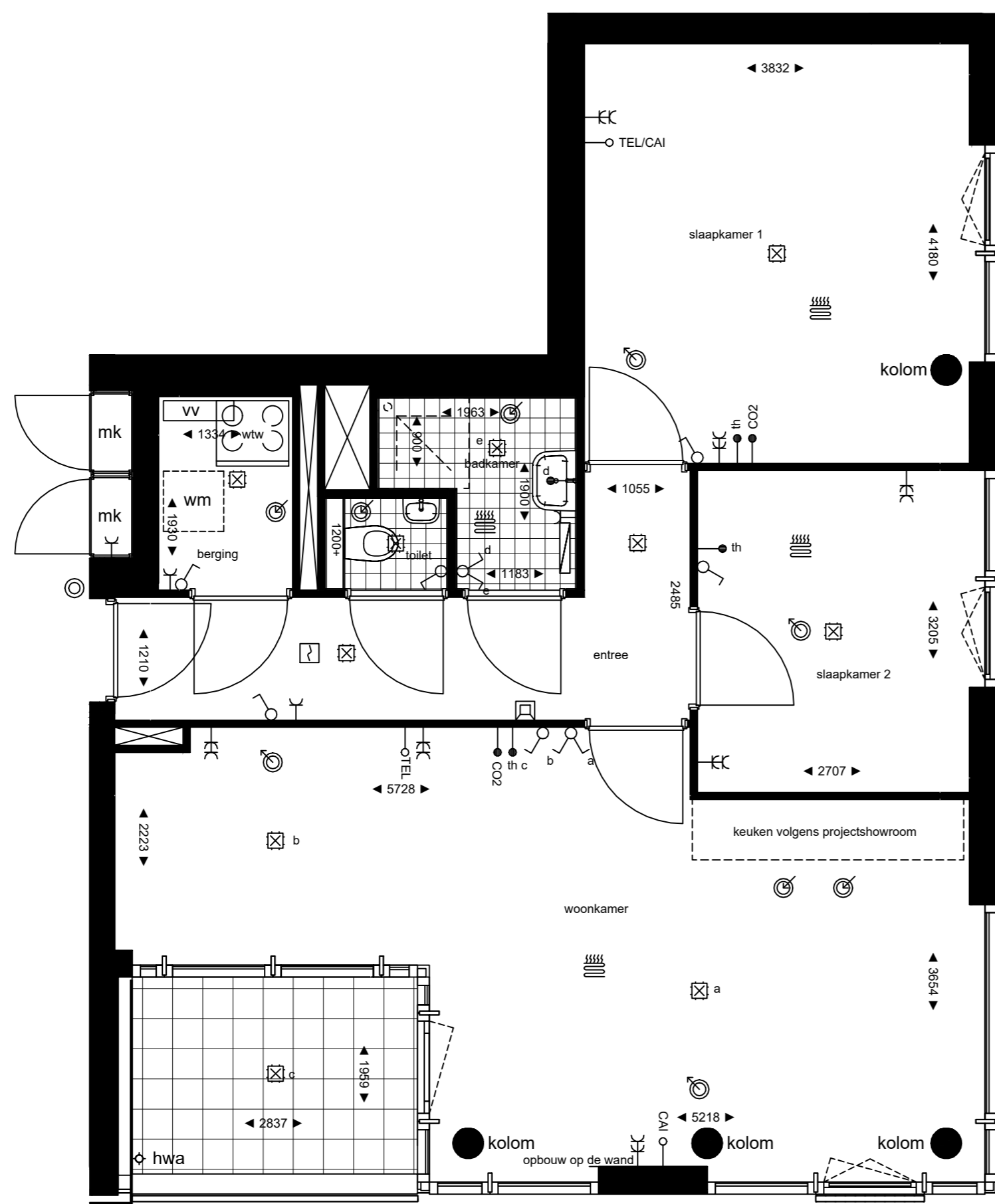















Renvooi

verkoop

-  WCD 230V enkelvoudig
-  WCD 230V dubbelvoudig
-  Schakelaar 230V enkelpolig
-  Schakelaar 230V serie
-  Wisselschakelaar 230V dubbelpolig
-  Aansluitpunt bedraad
-  Aansluitpunt loos
-  Wand lichtpunt
-  Centrale doos
-  Rookmelder
-  Videofoon
-  Drukknop

- th thermostaat
- mk meterkast
- CO2 CO2 meter

-  Inblaasventiel MV
-  Afzuigventiel MV
-  Inblaasventiel MV wand
-  Radiator
-  Vloerverwarming
-  Verwarming verdeler
-  MV-box met warmterugwinning
-  Opstelplaats voor wasmachine

-  Vloertegelwerk
-  Schacht
-  Verlaagd plafond
-  Kolom
-  Wand
-  Deur

Maatvoering is niet geschikt voor opdrachten van koper aan derden.

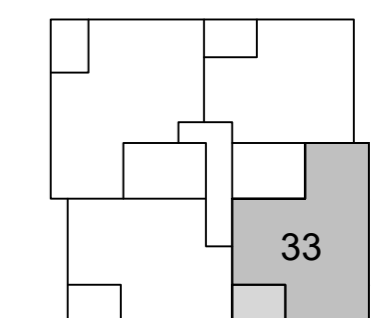
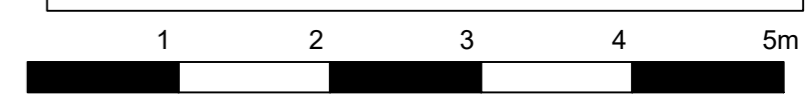

tweede verdieping



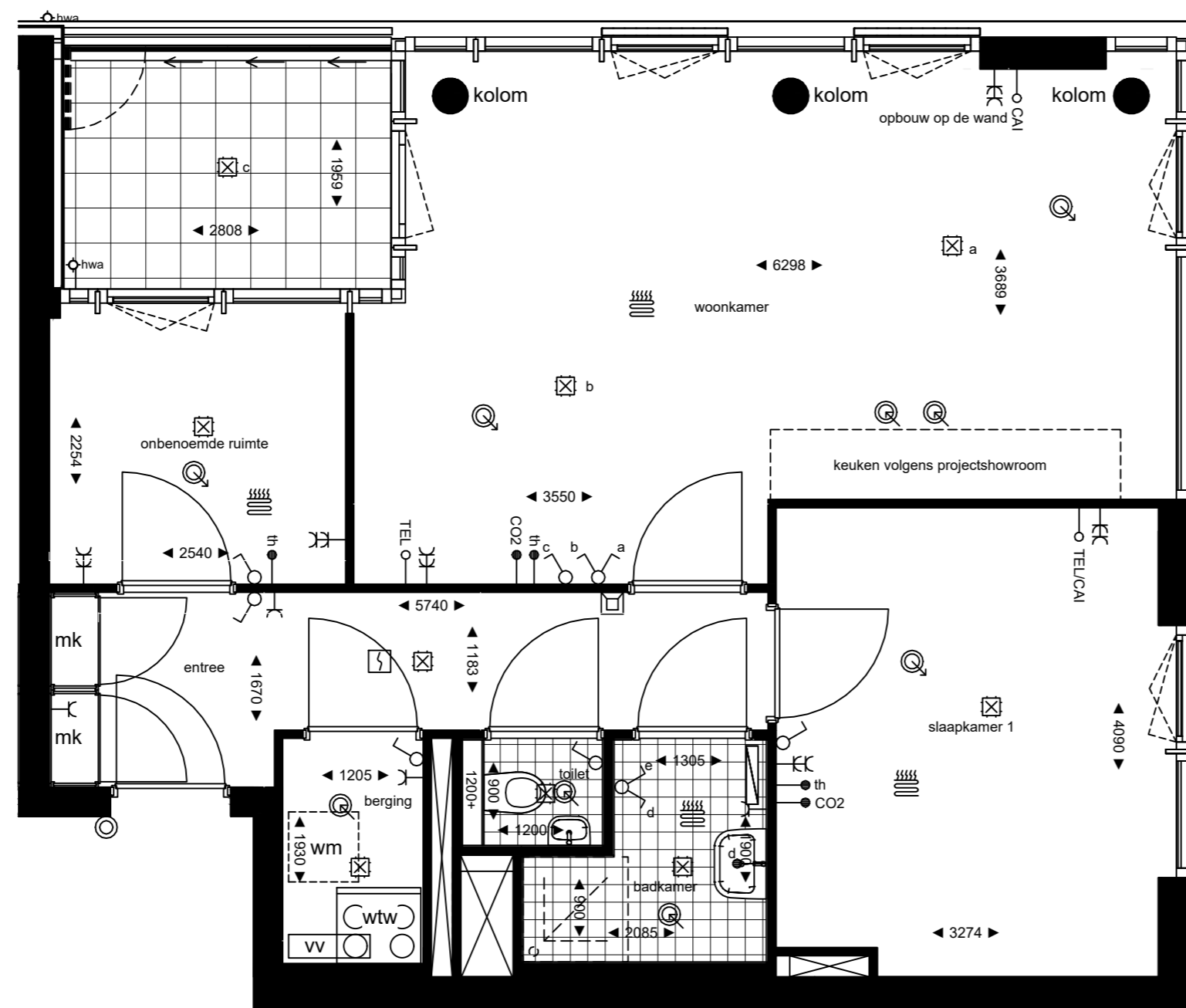















Renvooi

verkoop

-  WCD 230V enkelvoudig
-  WCD 230V dubbelvoudig
-  Schakelaar 230V enkelpolig
-  Schakelaar 230V serie
-  Wisselschakelaar 230V dubbelpolig
-  Aansluitpunt bedraad
-  Aansluitpunt loos
-  Wand lichtpunt
-  Centrale doos
-  Rookmelder
-  Videfoon
-  Drukknop

- th thermostaat
- mk meterkast
- CO2 CO2 meter

-  Inblaasventiel MV
-  Afzuigventiel MV
-  Inblaasventiel MV wand
-  Radiator
-  Vloerverwarming
-  Verwarming verdeler
-  MV-box met warmterugwinning
-  Opstelplaats voor wasmachine

-  Vloertegelwerk
-  Schacht
-  Verlaagd plafond
-  Kolom
-  Wand
-  Deur

Maatvoering is niet geschikt voor opdrachten van koper aan derden.

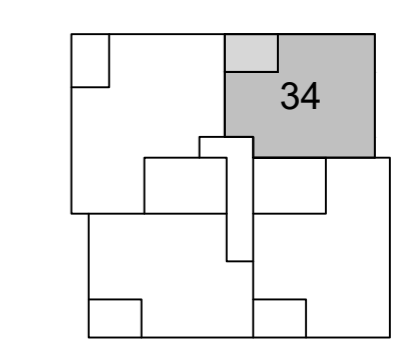
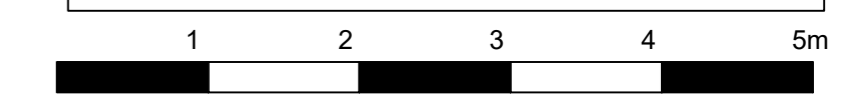

derde verdieping



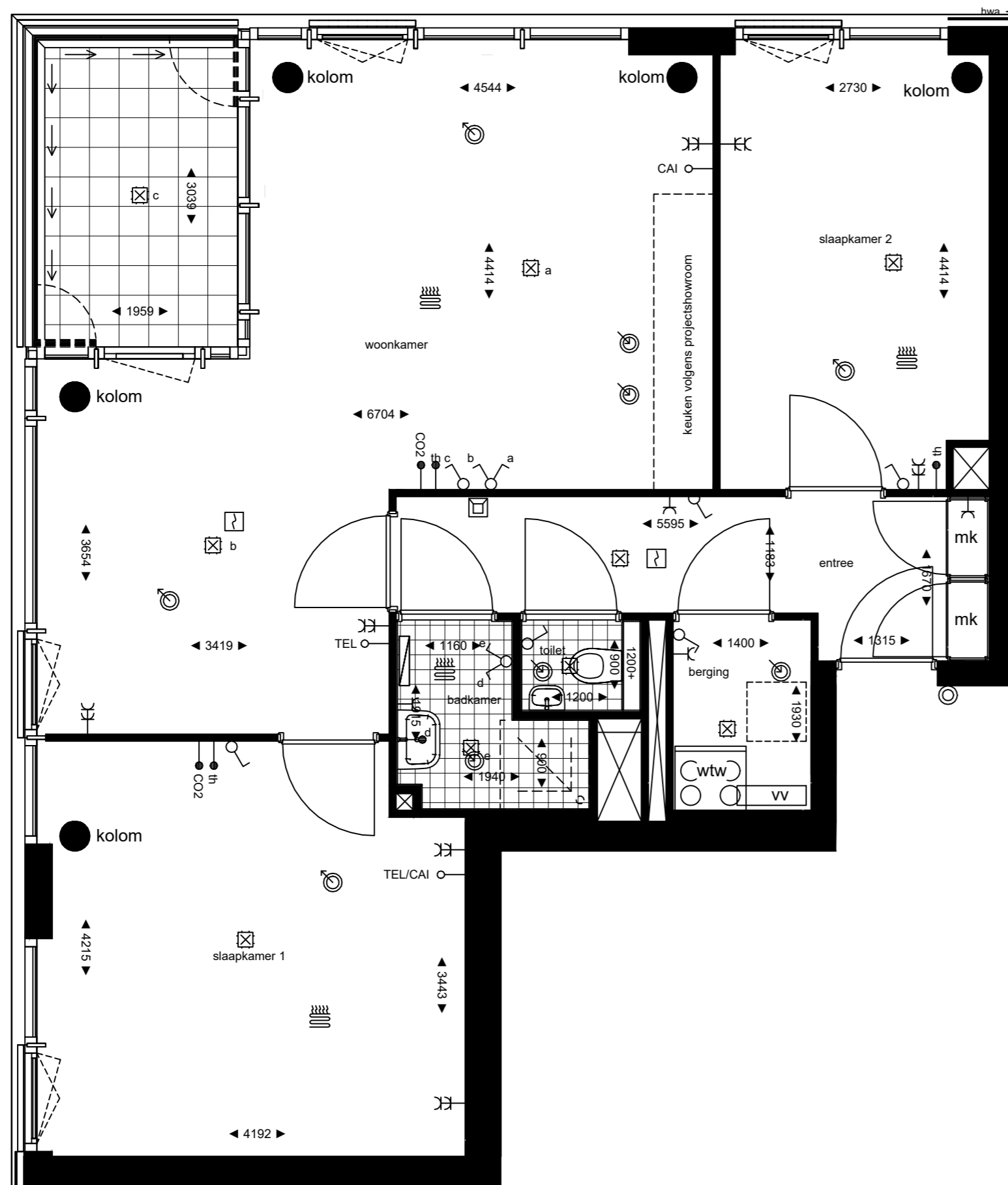















Renvooi

verkoop

-  WCD 230V enkelvoudig
-  WCD 230V dubbelvoudig
-  Schakelaar 230V enkelpolig
-  Schakelaar 230V serie
-  Wisselschakelaar 230V dubbelpolig
-  Aansluitpunt bedraad
-  Aansluitpunt loos
-  Wand lichtpunt
-  Centrale doos
-  Rookmelder
-  Videofoon
-  Drukknop

- th thermostaat
- mk meterkast
- CO2 CO2 meter

-  Inblaasventiel MV
-  Afzuigventiel MV
-  Inblaasventiel MV wand
-  Radiator
-  Vloerverwarming
-  Verwarming verdeler
-  MV-box met warmterugwinning
-  Opstelplaats voor wasmachine

-  Vloertegelwerk
-  Schacht
-  Verlaagd plafond
-  Kolom
-  Wand
-  Deur

Maatvoering is niet geschikt voor opdrachten van koper aan derden.

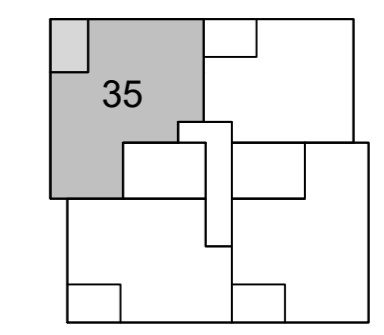
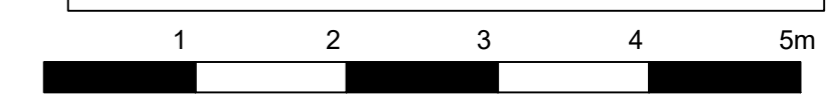

derde verdieping



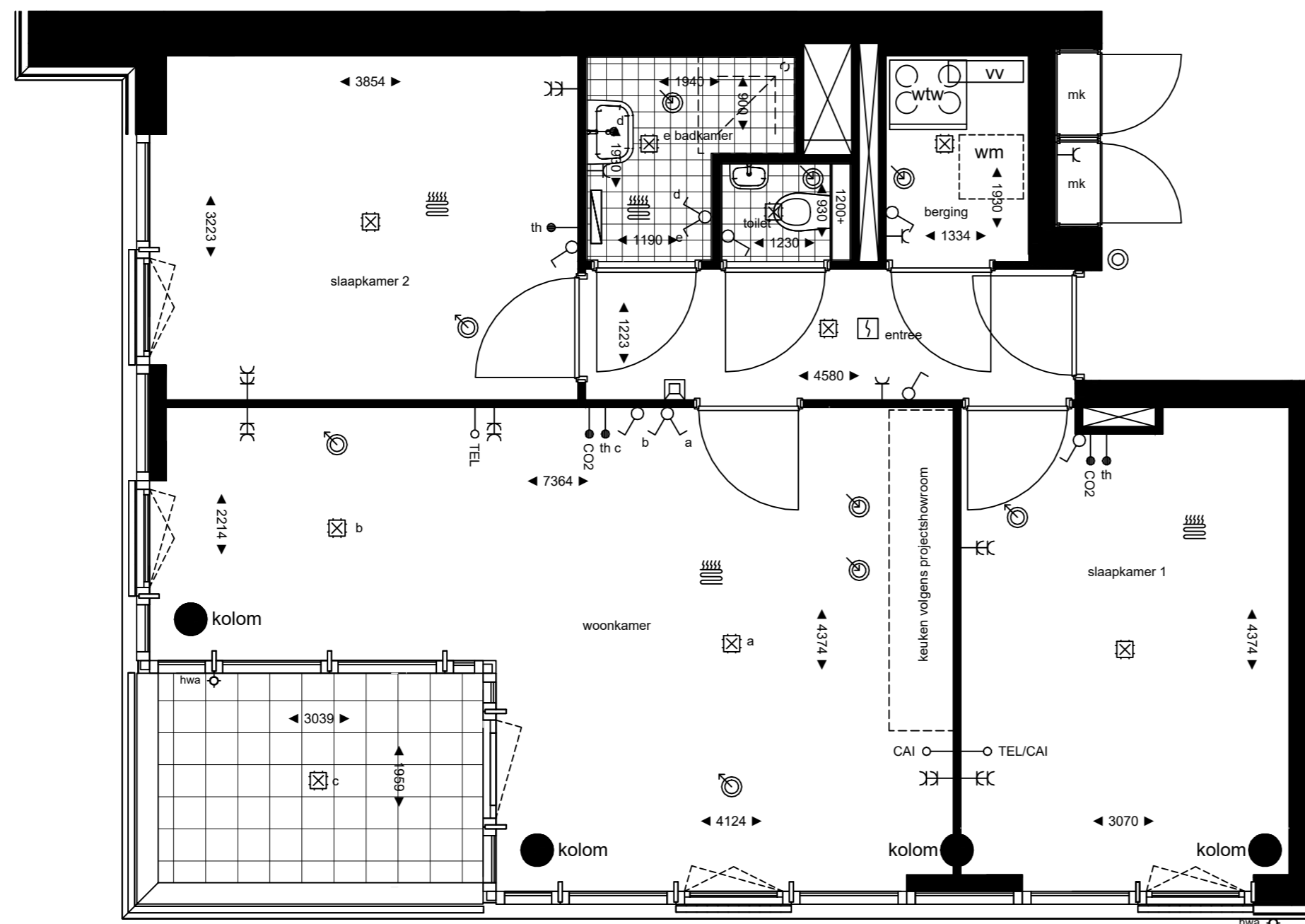

Renvooi

verkoop

- WCD 230V enkelvoudig
- WCD 230V dubbelvoudig
- Schakelaar 230V enkelpolig
- Schakelaar 230V serie
- Wisselschakelaar 230V dubbelpolig
- Aansluitpunt bedraad
- Aansluitpunt loos
- Wand lichtpunt
- Centrale doos
- Rookmelder
- Videofoon
- Drukknop

- th thermostaat
- mk meterkast
- CO2 CO2 meter

- Inblaasventiel MV
- Afzuigventiel MV
- Inblaasventiel MV wand
- Radiator
- Vloerverwarming
- Verwarming verdeler
- MV-box met warmterugwinning
- Opstelplaats voor wasmachine

- Vloertegelwerk
- Schacht
- Verlaagd plafond
- Kolom
- Wand
- Deur

Maatvoering is niet geschikt voor opdrachten van koper aan derden.

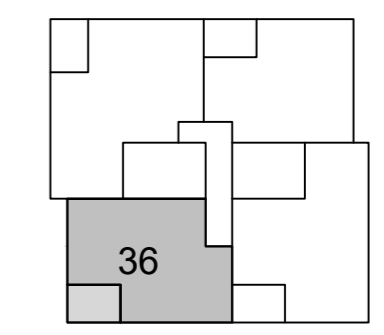
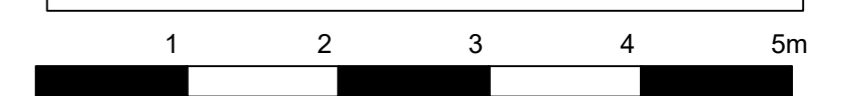

derde verdieping



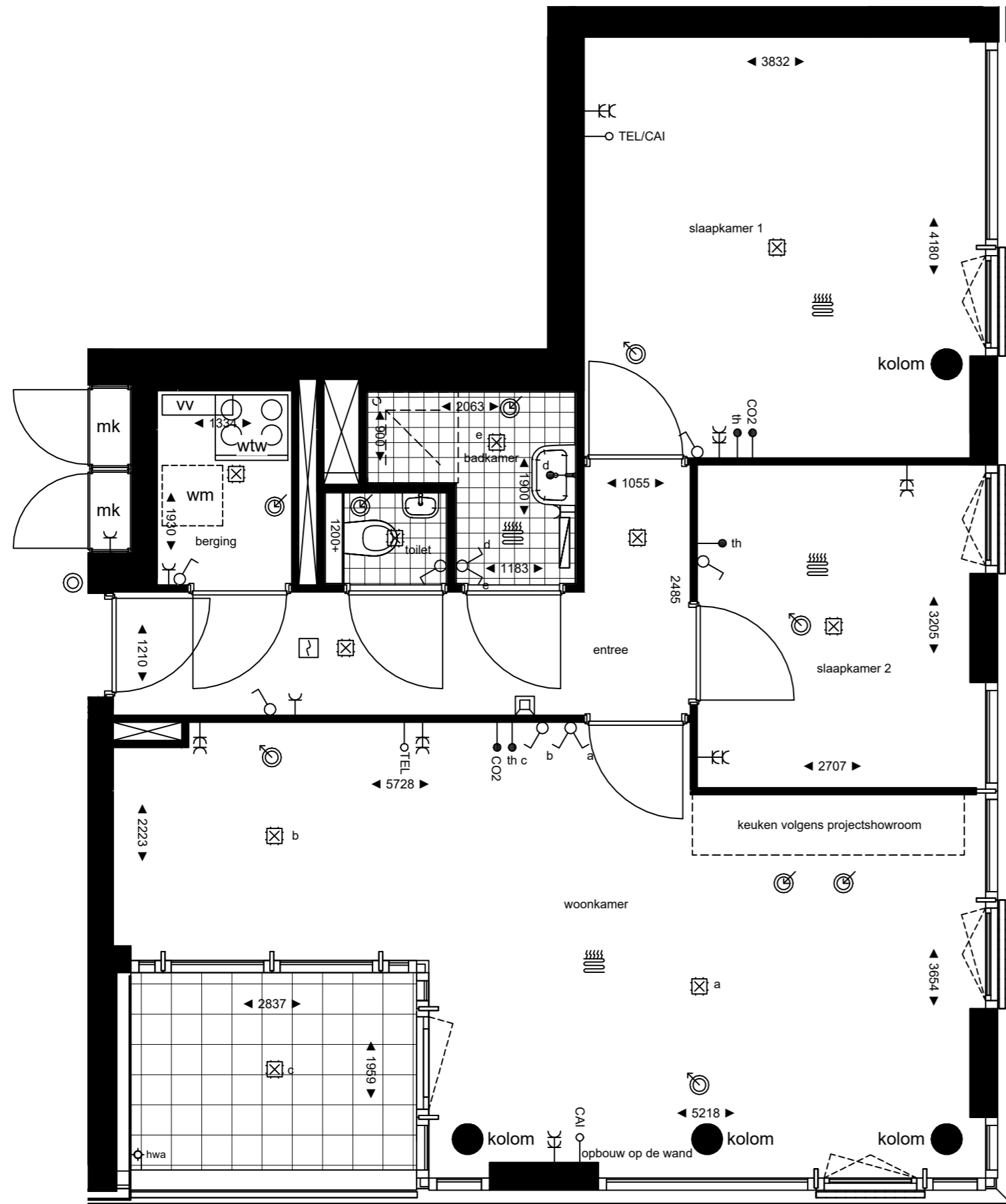

Renvooi

verkoop

- WCD 230V enkelvoudig
- WCD 230V dubbelvoudig
- Schakelaar 230V enkelpolig
- Schakelaar 230V serie
- Wisselschakelaar 230V dubbelpolig
- Aansluitpunt bedraad
- Aansluitpunt loos
- Wand lichtpunt
- Centrale doos
- Rookmelder
- Videofoon
- Drukknop

- th thermostaat
- mk meterkast
- CO2 CO2 meter

- Inblaasventiel MV
- Afzuigventiel MV
- Inblaasventiel MV wand
- Radiator
- Vloerverwarming
- Verwarming verdeler
- MV-box met warmterugwinning
- Opstelplaats voor wasmachine

- Vloertegelwerk
- Schacht
- Verlaagd plafond
- Kolom
- Wand
- Deur

Maatvoering is niet geschikt voor opdrachten van koper aan derden.

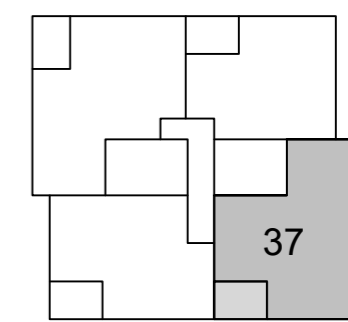

derde verdieping

















Renvooi

verkoop

-  WCD 230V enkelvoudig
-  WCD 230V dubbelvoudig
-  Schakelaar 230V enkelvoudig
-  Schakelaar 230V serie
-  Wisselschakelaar 230V dubbelpolig
-  Aansluitpunt bedraad
-  Aansluitpunt loos
-  Wand lichtpunt
-  Centrale doos
-  Rookmelder
-  Videofoon
-  Drukknop

- th thermostaat
- mk meterkast
- CO2 CO2 meter

-  Inblaasventiel MV
-  Afzuigventiel MV
-  Inblaasventiel MV wand
-  Radiator
-  Vloerverwarming
-  Verwarming verdeler
-  MV-box met warmterugwinning
-  Opstelplaats voor wasmachine

-  Vloertegelwerk
-  Schacht
-  Verlaagd plafond
-  Kolom
-  Wand
-  Deur

Maatvoering is niet geschikt voor opdrachten van koper aan derden.

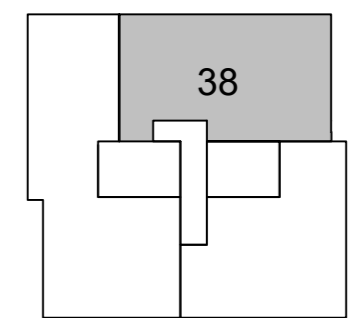

vierde verdieping

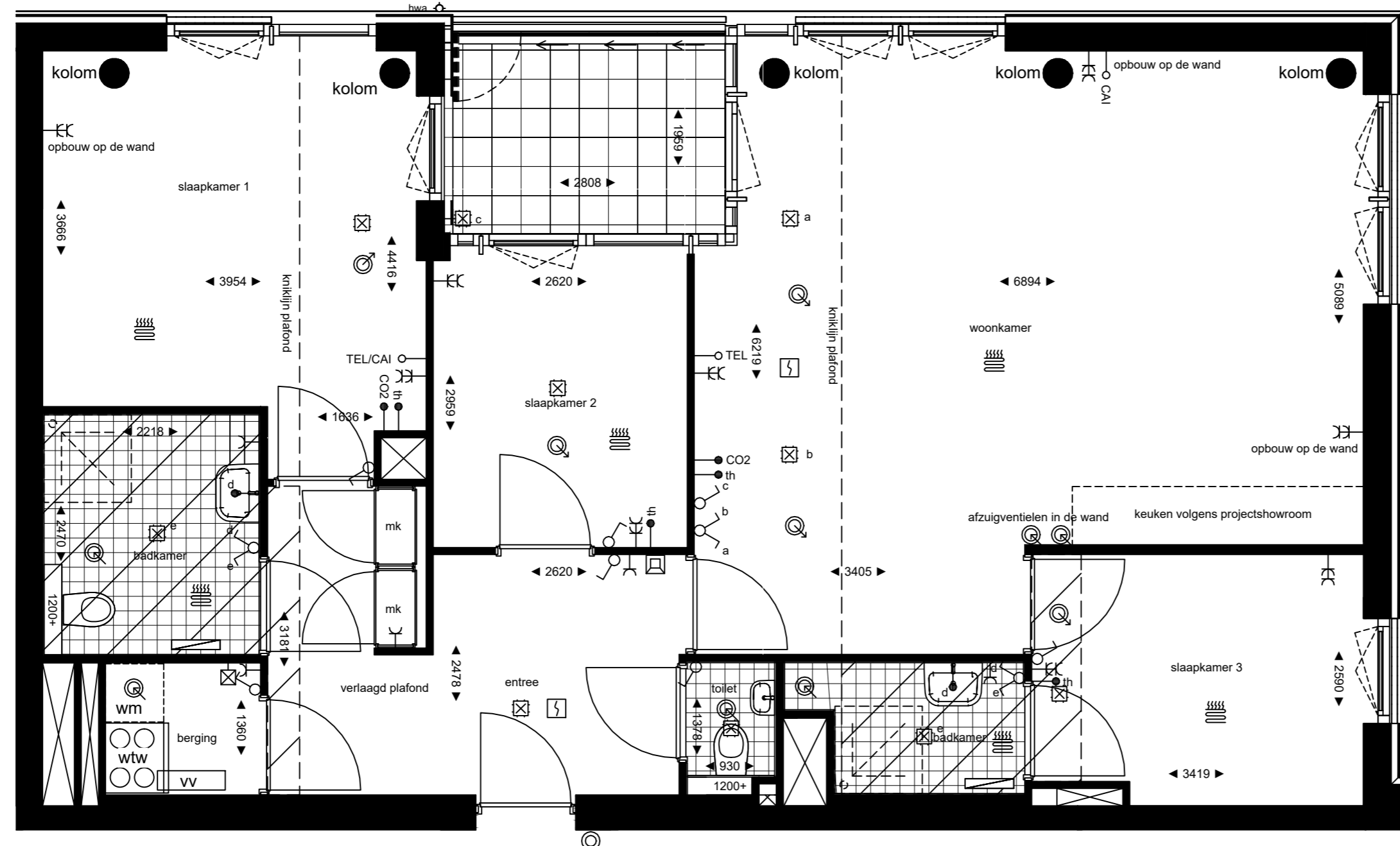

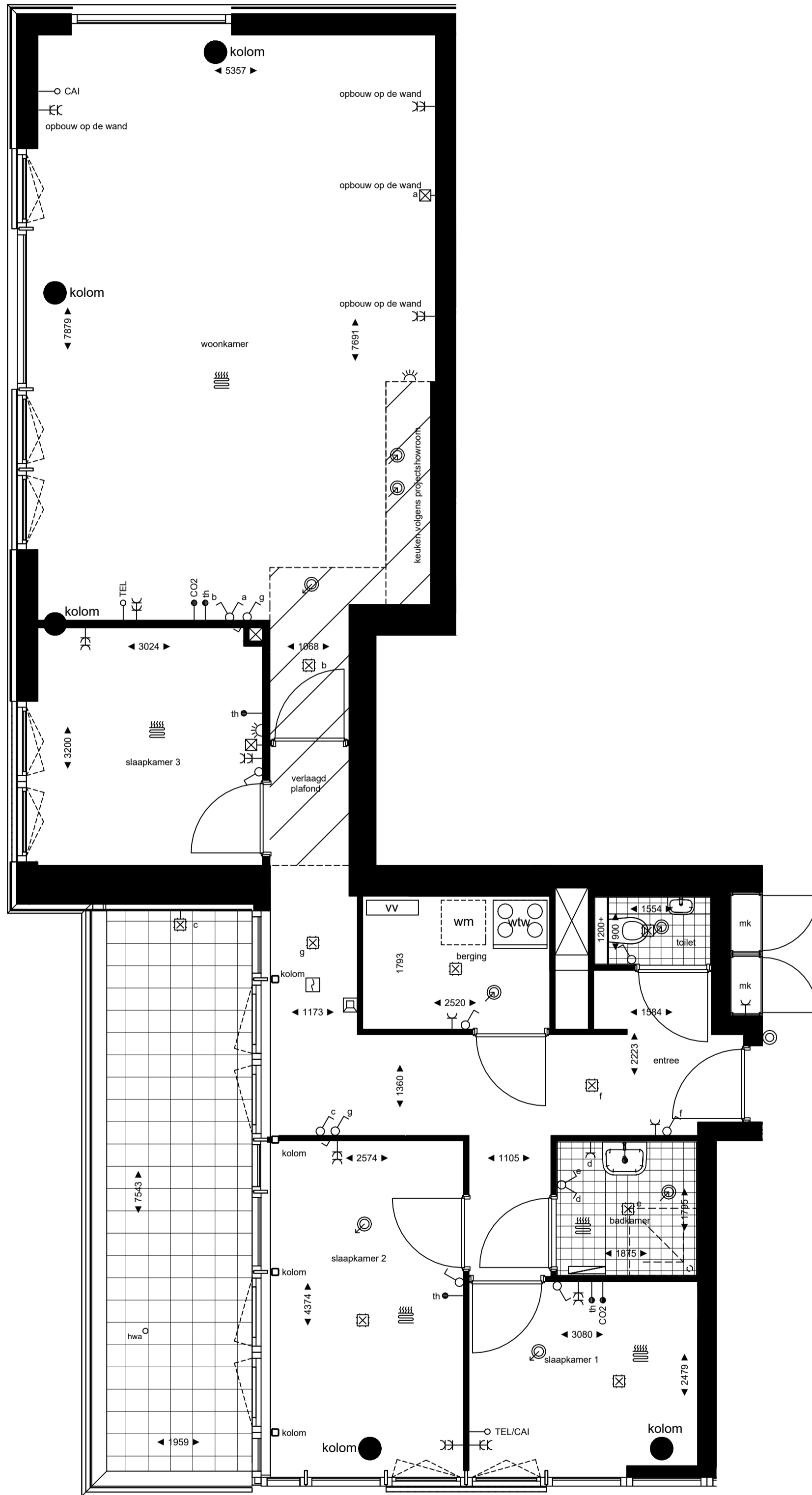

Renvooi verkoop

- WCD 230V enkelvoudig
- WCD 230V dubbelvoudig
- Schakelaar 230V enkelpolig
- Schakelaar 230V serie
- Wisselschakelaar 230V dubbelpolig
- Aansluitpunt bedraad
- Aansluitpunt loos
- Wand lichtpunt
- Centrale doos
- Rookmelder
- Videofoon
- Drukknop

- th thermostaat
- mk meterkast
- CO2 CO2 meter

- Inblaasventiel MV
- Afzuigventiel MV
- Inblaasventiel MV wand
- Radiator

- Vloerverwarming
- Verwarming verdeler
- MV-box met warmterugwinning
- Opstelplaats voor wasmachine

- Vloertegelwerk
- Schacht
- Verlaagd plafond
- Kolom
- Wand
- Deur

Maatvoering is niet geschikt voor opdrachten van koper aan derden.

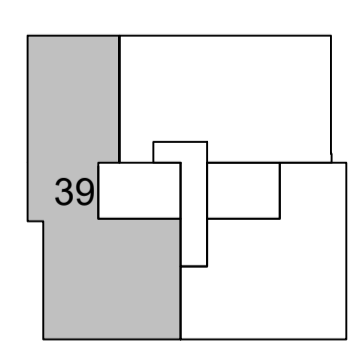

vierde verdieping



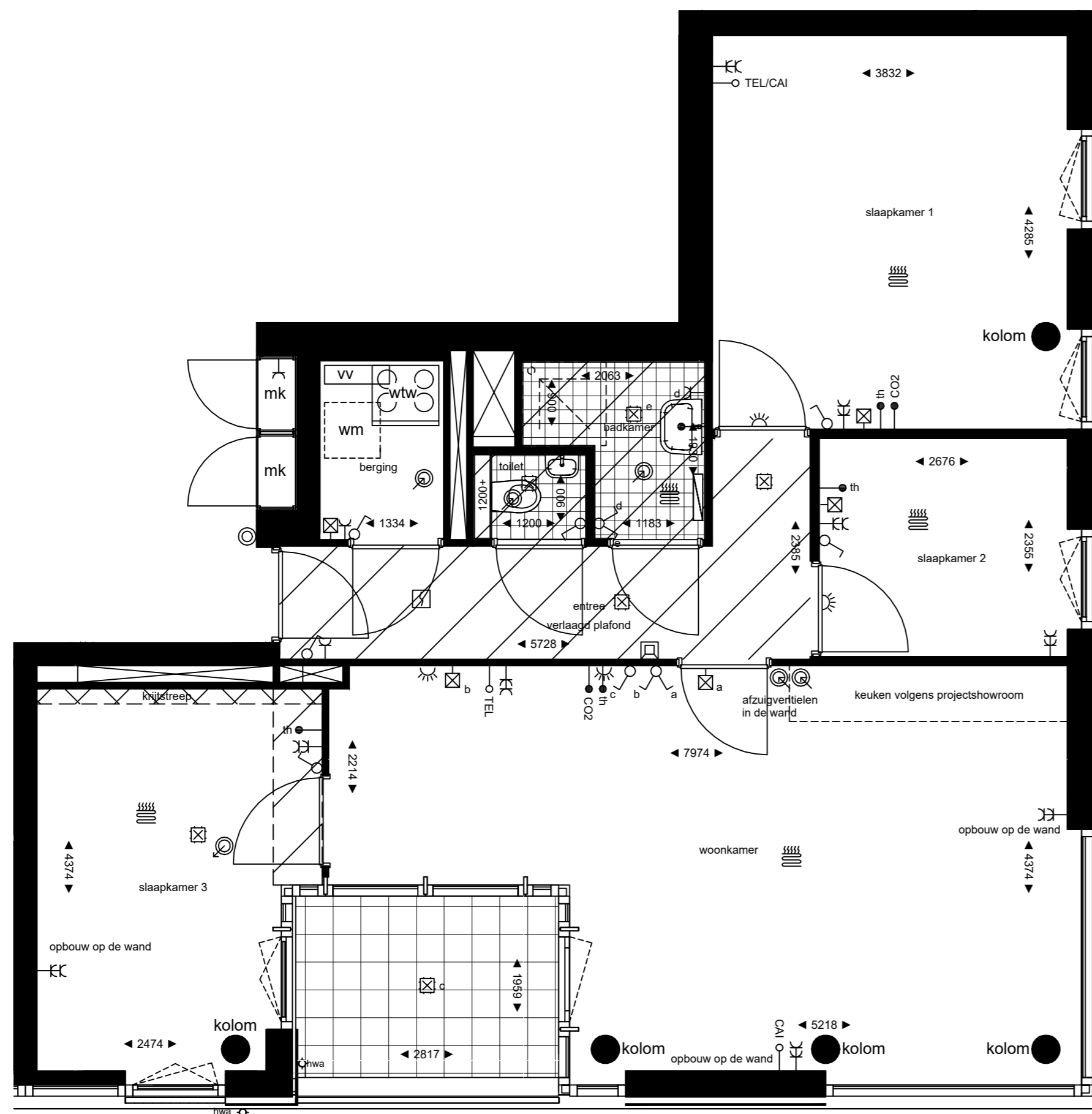









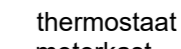
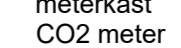
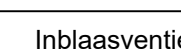







Renvooi

verkoop

-  WCD 230V enkelvoudig
-  WCD 230V dubbelvoudig
-  Schakelaar 230V enkelpolig
-  Schakelaar 230V serie
-  Wisselschakelaar 230V dubbelpolig
-  Aansluitpunt bedraad
-  Aansluitpunt loos
-  Wand lichtpunt
-  Centrale doos
-  Rookmelder
-  Videofoon
-  Drukknop

-  th
-  mk
-  CO2
-  thermostaat
-  meterkast
-  CO2 meter

-  Inblaasventiel MV
-  Afzuigventiel MV
-  Inblaasventiel MV wand
-  Radiator
-  Vloerverwarming
-  Verwarming verdeler
-  MV-box met warmterugwinning
-  Opstelplaats voor wasmachine

-  Vloertegelwerk
-  Schacht
-  Verlaagd plafond
-  Kolom
-  Wand
-  Deur

Maatvoering is niet geschikt voor opdrachten van koper aan derden.

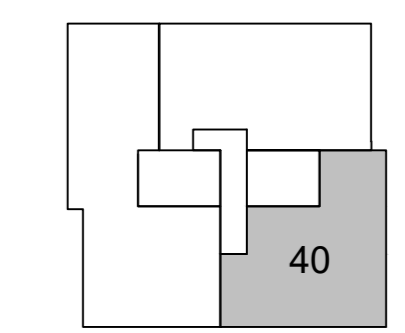

vierde verdieping

